



KREEPY KRAULY'S REVOLUTIONARY  
**ROBOTIC SUCTION CLEANER**  
OWNER'S MANUAL

## Congratulations

Your new rX-Tank is designed to give you years of reliable performance. Assembly is simple and we'll walk you through it, step-by-step.

This booklet should answer all your questions. However, if you need a little extra help, feel free to call our Customer Service Department, Mon-Fri 9-5 in your local area, or go to the Kreepy Krauly website for up-to-date information.

**1800 777 255**

**[www.kreepykrauly.com.au](http://www.kreepykrauly.com.au)**

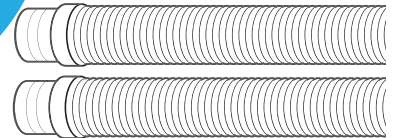

# COMPONENTS CHECKLIST

You will find all the pictured components inside this box.

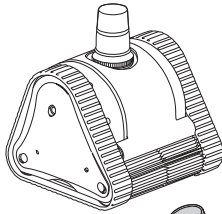

rX-Tank



Smart-Skim (Type 1)



Smart-Skim Adaptors



Hose Weight

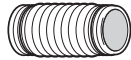

Flexible Hose Connector



rX-Anti Vortex Disc  
(Optional to stop air entering the system)

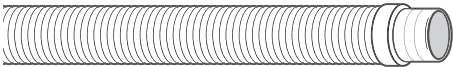

**X1** Male-to-Male X-Treme Flex Hose

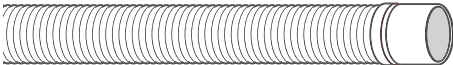

**X9** Male-to-Female X-Treme Flex Hose

**Auto Skim Upgrade:** For Premium Vacuum Control and heavy leaf debris. This upgrade replaces Smart-Skim and Smart Skim adaptors.



Anti Vortex Disc



Auto Skim Valve

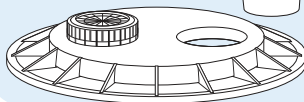

Custom Vacuum Plate  
(will vary according to your skimmer box)

## STEP 1

# PREPARE YOUR POOL

If your pool is clean, balanced and algae-free, you're ready to get started.

- a. First, clean the skimmer and pump basket.
- b. Check the water level.
- c. Brush down the sides of your pool.
- d. Next, make sure the return jets are facing downwards.
- e. Then, backwash or clean your cartridge filter.
- f. **Now turn off the pump.**

**TIP:** Before installing your rX-Tank, check the following:

**Vinyl-lined pool** – Check for signs of deterioration or damage to the liner. Remediate before installation.

**Tiled pool** – Check and repair any loose tiles.

## STEP 2

# ASSEMBLE THE CONNECTOR

- **Attach the Flexible Hose Connector** (the incredibly bendy small hose) to the top opening of your rX-Tank. This should fit snugly, if not, rotate 180°.

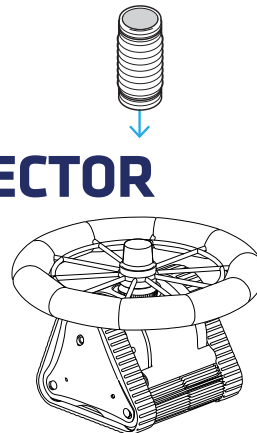

## Fit the Vacuum Control Valve (2 options)

### Smart-Skim (comes standard)

Insert the Smart-Skim into the adaptor fitting, then attach to your Vacuum Plate. Depending on the Vacuum Plate your pool uses, you may have to **use a different skim adaptor** – we've included three for you to choose from.

You know you're using the right **one** when there is a tight fit. See our Kreepy Krauly website if you need help.

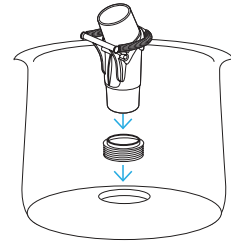

**TIP:** For Poolrite plates, use the first fitting, threading from the bottom (tapered side up) until it sits flush with base of the plate. This will ensure your valve opens freely.

**NOTE:** To remove, **ensure the pump is off** and grasp from the bottom of the Smart-Skim, pulling up. (Note: Not from the hose or spring).



used with most vacuum plates



used with Polyplastics 190 & 210 standard



used with Polyplastics SK1000 (rectangular)

**OR**

### Combined Vacuum Plate and Auto Skim Valve (optional upgrade)

Your pool shop would have already assisted you in selecting the correct replacement for your pool's existing vacuum plate. To assemble, place the Auto Skim Valve into the opening in the new Vacuum Plate. Attach the Anti-Vortex Disc over the valve inlet. Place the entire unit in the skimmer box.

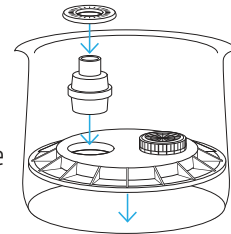

**NOTE:** A Vacuum Plate Clamp can stop your vacuum plate moving.

**TIP:** The Anti-Vortex Disc stops the slurping sound.

## STEP 3

# BUILD THE X-TREME FLEX HOSE

- **Start with the male-male hose** and twist on a female-male length. Keep going until the hose is long enough to reach from your skimmer box to the far corner of your pool. Now add one extra length – this will optimise the coverage of your rX-Tank.

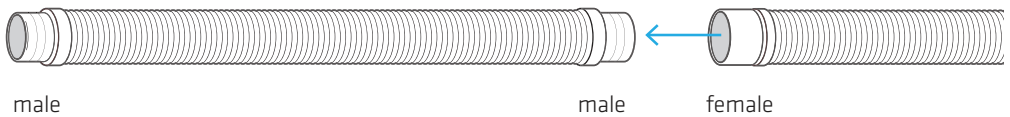

**TIP:** Wetting the hose ends in your pool will make them easier to fully connect to each other.

- **Attach your hose weight.** Position the weight 2m from the first male end.
- **Submerge the assembled hose** in your pool. To expel all the air, push downwards feeding the hose into the pool.

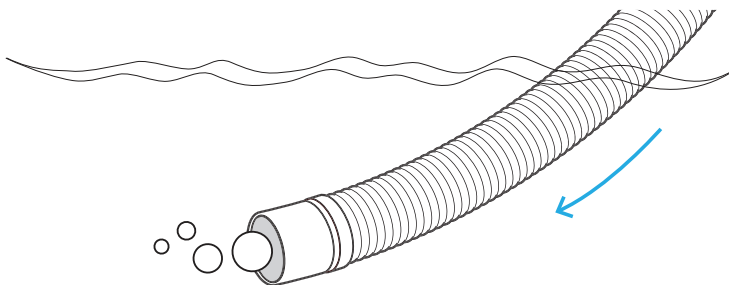

**TIP:** When removing or storing hose sections, store flat and not coiled to ensure extended life of the hose and prevent coverage issues.

## STEP 4

# CONNECT THE HOSE TO RX-TANK

- **Submerge the rX-Tank in your pool to expel all air.** You will need to fill each chamber in the halo by squeezing each chamber until there are no air bubbles inside. Each chamber needs to be filled with water one at a time.

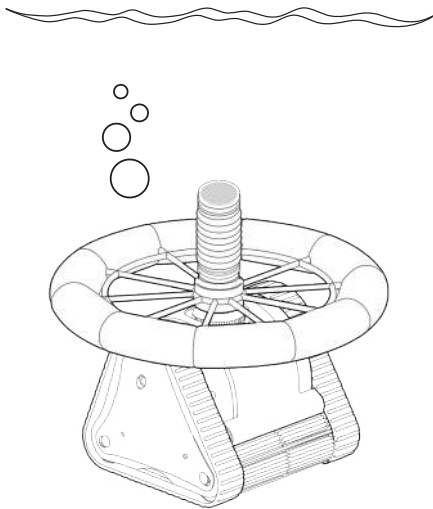

- **Connect the hose** (with the hose weight closest to the end) to the Flexible Hose Connector on your rX-Tank. Ensure the hose is submerged and free of air.

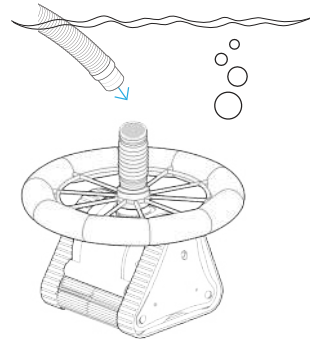

- **Connect the other end** of the hose to the Smart-Skim or Auto Skim upgrade (see setup on page 3) ensuring the end of the hose is submerged and free of air. Install the Anti Vortex Disc (optional) to stop air from entering the system when the water level is low.

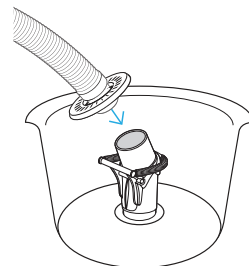

## STEP 5

# LET'S GET CLEANING

- Your rX-Tank is good to go – **simply turn the pump on**. There's no need to make any manual adjustment to the vacuum pressure; any excess vacuum will be used by the Smart-Skim or Auto Skim to provide surface skimming.
- All you need to do from here is remember to **empty the skimmer basket regularly**. Too easy!

**TIP:** Please be **suction aware** when working on your pool. Before undertaking any maintenance or troubleshooting, **ensure your pump is off** before handling your rX-Tank system.

**NOTE:** When removing your rX-Tank from the pool, do not carry using the flexible hose connector or halo. Carry supporting the underside of the cleaner.

### WARNING:

**Do not use non-genuine parts as the performance of your rX-Tank may be affected.**

**Thank you for choosing a genuine Kreepy Krauly Robotic Suction cleaner.**





# TROUBLESHOOTING

## If your rX-Tank isn't moving

- Check if the pump or filter basket needs cleaning, or if your filter needs backwashing or cleaning.
- Check there are no leaks in the hose or flexible hose connector. If there are, replace any damaged sections.
- Check the main drain and all suction lines are closed. The only one that should be open is the suction line that is attached to your rX-Tank.
- Check that your pool is balanced. Alkaline pools and algae can make the machine slip.
- Check that the Smart-Skim is opening and closing, and that the spring is still attached.
- Check that the Auto Skim (optional upgrade) is opening and closing freely. Remove the valve from your pool and open and close the valve in a bucket of clean water. If damaged, please replace.
- Your pool pump and filter system may be too small or inefficient to effectively run your rX-Tank. Ask your pool professional to advise. If you are using a variable speed pump and have plumbing losses, try adjusting your low speed setting up by 200rpm.
- There may be air in your rX-Tank. Turn the pump off and inspect the rX-Tank's Halo for air. If air is present, simply squeeze the chambers, whilst holding under water, until no air bubbles remain. When you release the cleaner, the rX-Tank should sink to the bottom of the pool.
- There may be a blockage in the rX-Tank. Turn off the pump and remove the halo from the cleaner pulling vertically upwards, holding onto the grey swivel, and inspect the cleaner for blockages from the

top and bottom. Clear the blockage if required. If the grey swivel is disconnected, ensure the stainless steel washer is present inside the swivel before pushing it firmly back onto the cleaner.

- Check there is sufficient tread on the tracks of the cleaner and replace if required.
- Turn off your pump and remove the cleaner from the pool. Lay on a flat surface, and gently with two hands, check the tracks can move back and forth. If there is an issue, consult your local pool professional.

### **If your rX-Tank is floating or hovering in your pool**

- Check if your cleaner has air trapped in the Halo. Air bubbles will be visible in the chambers. To remove trapped air, hold the cleaner under water and gently squeeze each chamber that has visible air bubbles to release the air and fill entirely with water.

### **Cleaner is turning in circles**

- Turn off the pump and remove the cleaner from the pool. Check the tracks can move freely both sides. If one or both is jammed, or an audible rough noise can be heard, please consult your local pool professional.

### **rX-Tank is climbing out of the pool**

- Check if the tracks are worn. Replace parts as required.
- Ensure your Halo is fitted to the rX-Tank. Reinstall if required.
- You may have too much vacuum going to the cleaner. Check your Smart-Skim or Auto Skim is installed and moving freely. Replace spring on Smart-Skim if required. Try cleaning Auto Skim in clean water by moving the collar up and down to flush out debris. If stiff or damaged, you may need to replace your AutoSkim.

## **rX-Tank is only cleaning one end or restricted in its coverage**

- Check that the hose is not coiled or kinked.

### ***To uncoil the hose:***

- Simply rotate every second 1m hose length 180 degrees until it is straight again.
- In hot weather (above 28°C), remove the cleaner and hose from the pool and lay the hose only flat for a day. The heat will make the hose relax and uncoil.
- In cooler weather, remove the hose from the pool. Prop both ends of the hose around 20cm off the ground. Pour a bucket of warm water (50-60°C) into the hose until it spills out of the other end. Carefully roll the hose side to side to ensure even warming. After 5 minutes, fill the hose with cold water – either with a bucket or by placing the hose end onto the pool outlet.
- Check that the return line water flow is directed downwards or sideways. Redirect it as necessary with a return line diverter. If that still doesn't work, you may need to purchase an Eyeball Diverter from your local Kreepy Krauly retailer.
- Check that the hose weight is fitted as described on page 6.

**NOTE:** For more detailed troubleshooting advice, please contact your helpful local dealer, or check our online resources for hints, tips and other information at [www.kreepykrauly.com.au](http://www.kreepykrauly.com.au) or visit our YouTube channel under Kreepy Krauly Troubleshooting [www.youtube.com](http://www.youtube.com)

# A HISTORY OF INNOVATION

Kreepy Krauly is unique vortex cleaning action was pioneered by Ferdinand Chauvier, a South African hydraulics engineer. This first Mark II cleaner although revolutionary in its solution to pool cleaning, was heavy, inefficient and did not withstand harsh pool conditions. Terry Jackson, Managing Director of Sherwood Overseas Company, a Western Australian manufacturer and exporter of above ground pools, brought the product to Australia and set about refining the Mark II cleaner for the Australian market. Every single component was completely redesigned and new materials were selected to enable the machine to be totally manufactured from durable injected moulded or extruded plastics.

The Kreepy Krauly “Mark II” was launched in Australia in 1976 and was an immediate success. Sherwood was soon exporting the Australian-made Kreepy Krauly to over 19 countries.

# WHAT SHOULD I EXPECT FROM MY RX-TANK?

## How it moves

The heart of this robotic suction cleaner is a powerful turbine. It efficiently uses your pool's suction to drive the cleaners tracks, gearing system and power brushes to quietly and efficiently clean your pool's surface. It navigates the tightest of corners moving freely around obstacles to give your pool unbeatable coverage.

## How it steers

X-Nav™ technology with a dual drive coverage system independently navigates rX-Tank in any direction across the floor and wall. It intelligently creates a cleaning path for your pool and effortlessly cleans automatically. With its advanced power steering Halo, it allows the cleaner unbeatable wall traction for multi-angle wall cleaning, and ensures your cleaner releases from the pool wall preventing air from entering the system.

## How it cleans

rX-Tank cleans your pool daily with your normal filter cycle by utilising its X-Treme Clean Power Brushes to lift dirt and debris to Vortex Vacuum your pool surface. As the cleaner moves around your pool daily it assists in circulating water from different areas of your pool through to your purpose built filtration and sanitation system to reduce dead spots. Leaves are picked up and pulled through the straight-through turbine heart of the cleaner, direct to your skimmer box for hassle free cleaning. The Vortex Vacuum design aids in the pick up of heavier debris such as sand and grit that can be left by other cleaners. The Smart-Skim or Auto Skim uses the excess vacuum to draw water into your skimmer box to help reduce floating debris.

## The X-Treme Flex Hose

To achieve coverage of your pool, the X-Treme Flex Hose provides the freedom your cleaner needs to navigate your pool. Its unique design rests just below the water surface due to its natural buoyancy.

# LOOKING AFTER YOUR RX-TANK

- Clean out the skimmer basket regularly.
- To safely remove the Smart-Skim or Auto Skim from the skimmer box, please switch off your pump first. Then take the hose off before gripping the Smart-Skim or Auto Skim at the base and gently pull upwards.
- Manually open and close the Smart-Skim or Auto Skim occasionally to flush away accumulated dirt and debris.
- Monitor your rX-Tank's tracks and flexible hose connector occasionally for wear and tear.
- Always carry the cleaner supporting the underside of the cleaner, not by the Flexible Hose Connector or Halo.

## Beware of the pool blanket effect

Pool blankets prevent chlorine evaporating. If you're using one, carefully monitor your chlorine or salt water setting to avoid over chlorinating your pool, which can harm your rX-Tank and void your warranty. If you have any questions, please call our Customer Service department on 1800 777 255 or talk to your pool shop pro.

# YOUR WARRANTY

Your rX-Tank is engineered to last. This is reflected in the 2-year Full System Warranty and 10-year Flow Turbine Warranty.

## Protecting Your Warranty

All Kreepy Krauly pool cleaning systems are made in Australia to withstand harsh Australian conditions. They are manufactured from top quality materials that are UV, salt and chemical resistant. Being an Australian company, we offer local after sales service, maintenance and parts. For any troubleshooting with your rX-Tank, simply contact your local pool shop for assistance. You will extend the life of your rX-Tank by using genuine rX-Tank parts and chlorinating your pool correctly. The use of non-genuine parts and over-chlorinating or overtreating your pool may void your warranty, impair your rX-Tank's performance or result in colour fade.

We recommend you remove your rX-Tank from the pool before chemically shocking your pool.

## Activating Your rX-Tank Warranty

To activate your 2-year Full System Warranty and 10-year Flow Turbine Warranty, please fill in your rX-Tank's serial number and return the self-addressed warranty registration card to us as soon as possible. Alternatively, you can activate your 2-year Full System Warranty and 10-year Flow Turbine Warranty online at [www.kreepykrauly.com.au/warranty](http://www.kreepykrauly.com.au/warranty).

**Record Serial Number Here:**

**TIP:** Your Serial Number can be found on the packaging or on a waterproof sticker on the rear of your rX-Tank.

**NOTE:** For full warranty conditions, please refer to your warranty card or go online to [www.kreepykrauly.com.au/warranty](http://www.kreepykrauly.com.au/warranty)

## FURTHER INFORMATION

This booklet should have answered all your questions. However, if you need a little extra help or up-to-date information, go to **[www.kreepykrauly.com.au](http://www.kreepykrauly.com.au)**, or call our Customer Service Department on 1800 777 255, Monday to Friday 9am-5pm in your local area. Alternatively, contact your local pool shop professional.



**[www.kreepykrauly.com.au](http://www.kreepykrauly.com.au)**

We reserve the right to revise, change, or modify rX-Tank without incurring any obligations to make like changes on rX-Tanks previously sold. This publication remains the sole copyright of Sherwood Overseas Co Pty Ltd.